

Fail-secured Type Electric Deadbolt DA-64NS

Fail secured Magnet



Specifications

Model No.:	DA-64NS
Approx. weight:	675g±1%
Nominal voltage:	DC12V
Standby current:	18mA
Working current:	440mA
Temp. range:	-20°C~70°C
Power consumption:	0.2W(Standby) / 5.3W(Work)

- Features:**
- *Fail secured type.(Released as energized.)
 - *Drop to hold positioning by magnet.
 - *With magnetic switch door position sensor.
 - *Low working current, no over heating problem.
 - *With DIP switch for setting time delay for opening & relock door.
 - *Electric drop bolt design suitable for double swing door with 180° opening angle.
 - *With LED for indicating power & bolt status.

Applications: For aluminum, steel, wooden or brass door.

Deadbolt releaser DAR-24

With Patent



Features

Deadbolt releaser is the device installed on the door panel to pair with the general deadbolt lock which is installed on the door jamb for auxiliary releasing the bolt during either in damaged or power failing condition. Especially for the fail safe type deadbolt which is unable to release the bolt during power failure.

Applications

For aluminum, steel, wooden or brass door.

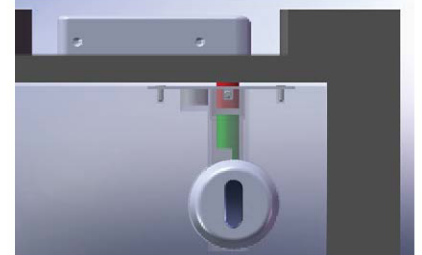
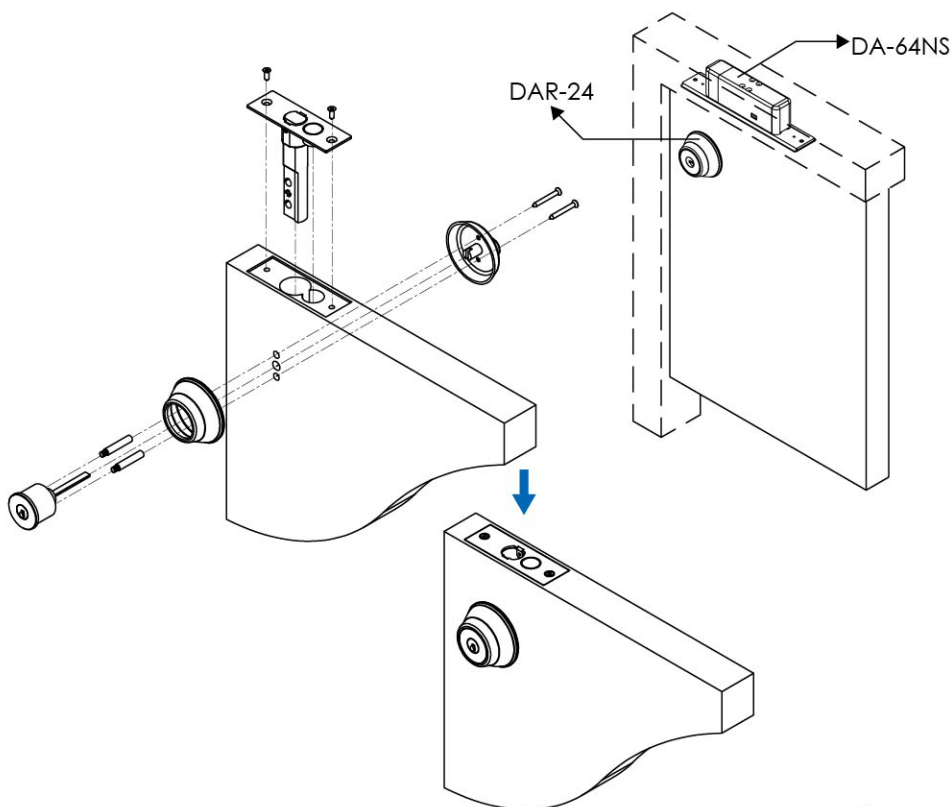

Deadbolt which is unable to release the bolt during power failure.

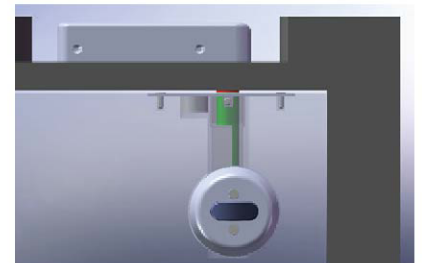

By(DAR-24) key or knob to open.

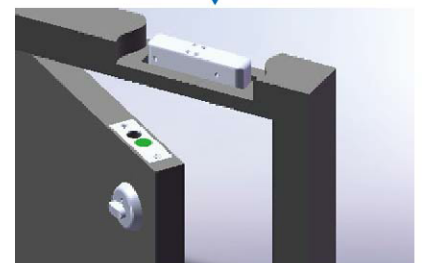

Door opened

Fail-secured Type Electric Deadbolt DA-66SL

Specifications

Model No.	: DA-66SL
Approx. weight	: 350g±1%
Nominal voltage	: DC12V
Standby current	: 230mA
Working current	: 1000mA
Temp. range	: -20°C~70°C
Power consumption	: 2.8W(Standby) / 12W(Work)
Features	: *Fail secured type.(Released as energized.) *Drop to hold positioning by magnet. *With magnetic switch door position sensor. *Low working current, no over heating problem. *With DIP switch for setting time delay for opening & relock door. *Electric drop bolt design suitable for double swing door with 180° opening angle. *With LED for indicating power & bolt status.
Applications:	: For aluminum, steel, wooden or brass door.

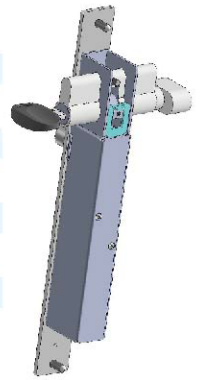

Fail secured



Euro-profile Thumb Turn Cylinder SL-70E

SL-70E

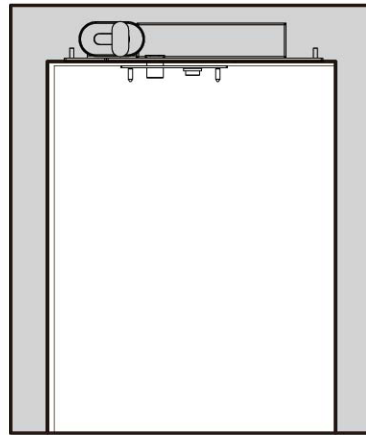

Top Mounting

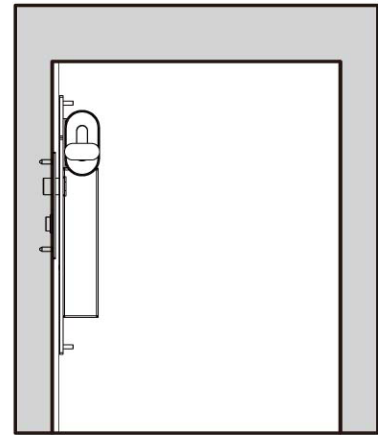

Side Mounting

Dimensions mm

Installation for Wooden Door

Installation for Metallic Door

